

# PARTS & ACCESSORIES CATALOG

©2004 Performance Trailers, Inc.

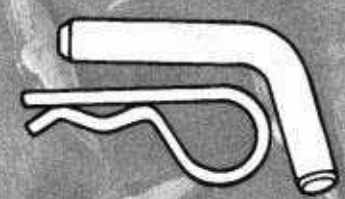

6 1/2 Acres of Trailers, 1/2 mile from Rt. 80 Exit 27A

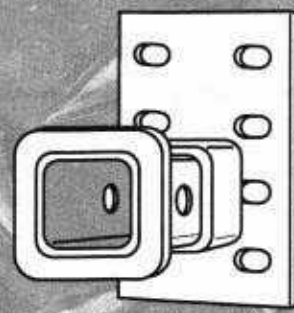
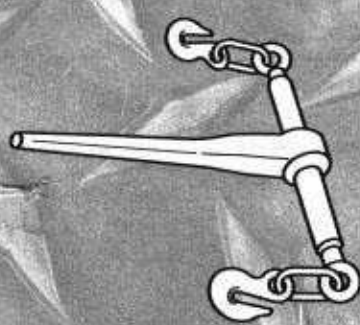
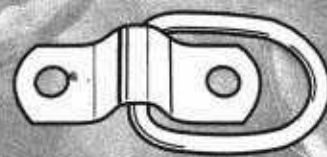
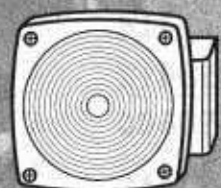

VISIT OUR WEBSITE

Traileroutlet.com

# Tie Down Parts

**Part No.**      **Description**

---

**HPWC**      Hitch pin w/clip  
5/8" dia. for 2" receiver tubes

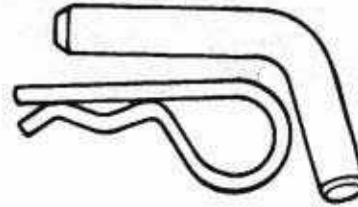

**SHPWC**      Hitch pin w/clip  
1/2" dia. for 1-1/4" Class II  
receiver tubes

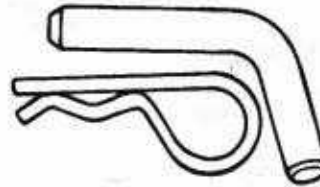

**SP1.75**      1-3/4" wide snapper pin  
**SP2.50**      2-1/2" wide snapper pin  
**SP3.00**      3" wide snapper pin  
**SP3.50**      3-1/2" wide snapper pin

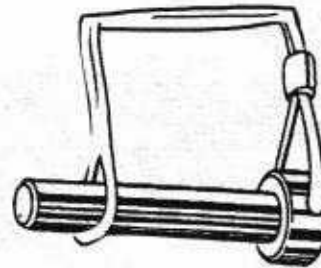

**HP1200**      3-1/2" x 1/2"  
**HP12414**      4-1/4" x 1/2"  
**HP58412**      4-1/2" x 5/8"  
**HP58600**      6" x 5/8"  
**HP34412**      4-1/2" x 3/4"  
**HP34600**      6" x 3/4"  
**HP10600**      6" x 1"

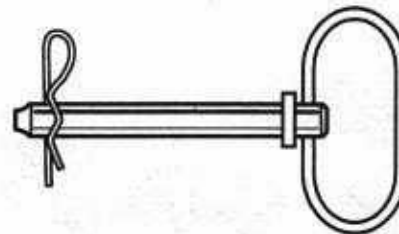

**SDR700**      Small 500 lb.  
Rated D-ring

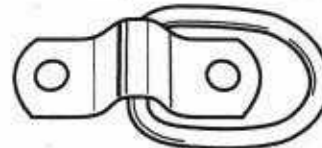

**DR70ISM**      Surface Mount  
D-ring 500 lb., 4" O.D.

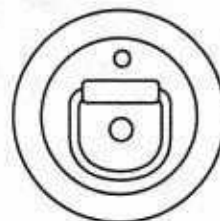

# Tie Down Parts

Part No. Description

**DR60I** Recessed D-ring  
1200 lb. capacity

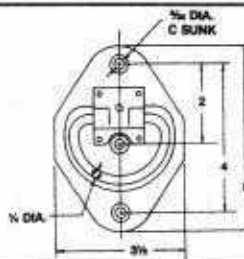

**DR80I** Heavy Duty D-ring  
5,000 lb. capacity

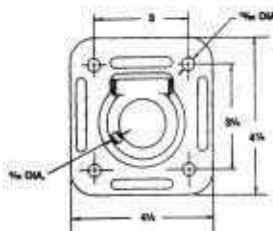

**DR58W** Forged heavy duty 5/8"  
D-ring with weld-on bracket



**DR38B** Forged heavy duty  
D-ring with bolt-on bracket

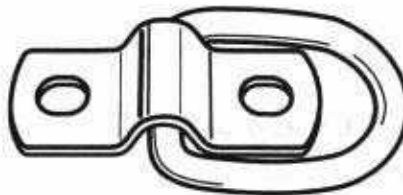

**RB** Ratchet binder

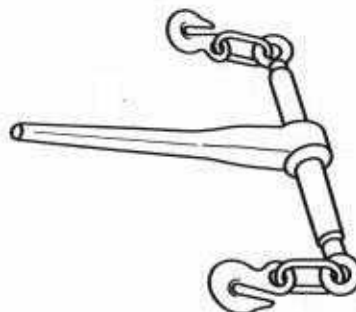

**DH** Document holder

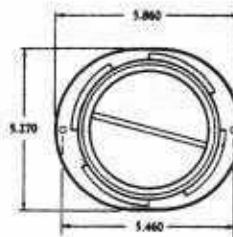

# Hitch Parts

Part No. Description

## Chrome Hitch Balls

- B178** 1-7/8" ball X 3/4" shank X 2-1/8" long
- B2342** 2" ball X 3/4" shank X 2-1/8" long
- B212** 2" ball X 1" shank X 2-1/8" long
- B251** 2-5/16" ball X 1" shank X 2-1/8" long
- B25125** 2-5/16" ball X 1-1/4" shank X 2-1/8" long



## Interchangeable Hitch Balls

- AB57900** 3 sizes: 1-7/8", 2", 2-5/16"

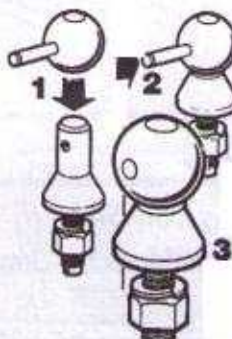

## Ball Mounts - 5,000 lb. rating

- BM280** 8" L x 2" drop
  - BM210** 10" L x 2" drop
  - BM409** 9" L x 4" drop
  - BM410** 10-3/4" L x 4" drop
  - BM611** 11-5/8" L x 6" drop
- Other sizes available - call

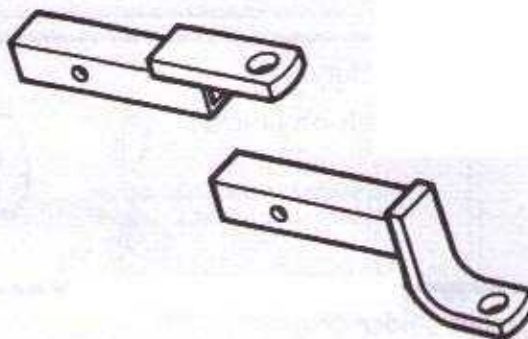

## Pintle Replacement Ball

- PRB2** 2" pintle ball
- PRB2516** 2-5/16" pintle ball

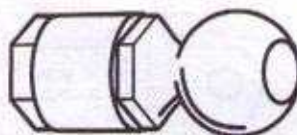

## PBOLTS

- Pintle bolt package
- 4 pcs. each: 1/2-13x2 GR8,  
1/2-13L9 Hvy Nut, 1/2 USS HD Flat,  
1/2 HD Lockwasher

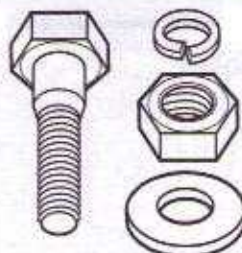

# Hitch Parts

**Part No.**      **Description**

**SBH**      Receiver tube bumper hitch  
Bolts under bumper  
to give you a receiver tube hitch.

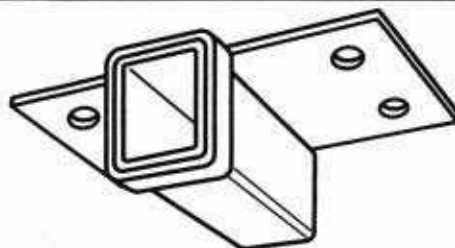

**RT12**      12" receiver tube  
**RT24**      24" receiver tube

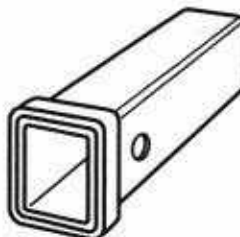

**RT8P**      Bolt-On Receiver Tube.  
Converts your plate hitch to a  
receiver tube. 2" receiver tube  
welded to 1/2" thick 4-hole  
steel mounting plate. Cast steel  
collar, black powder coat finish,  
5/8" hitch pin hole

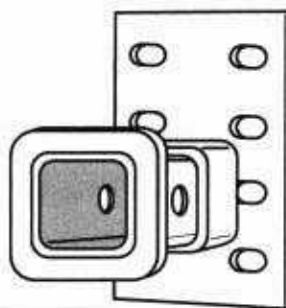

**GH**      5400 lb. grab hook



**SH**      5400 lb. snap hook



**QL**      3/8" quick link

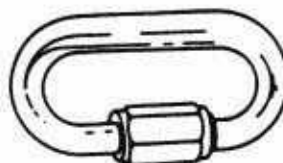

# Hitch Parts

Part No.

Description

**LDSC**

9/32" x 54" safety chain  
with 2 S-hooks

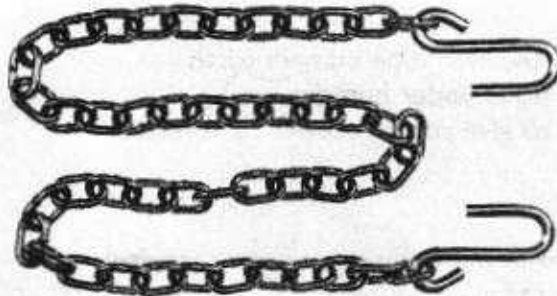

**HDSC**

Heavy duty safety chain  
3/8" x 35" long  
with latch hooks

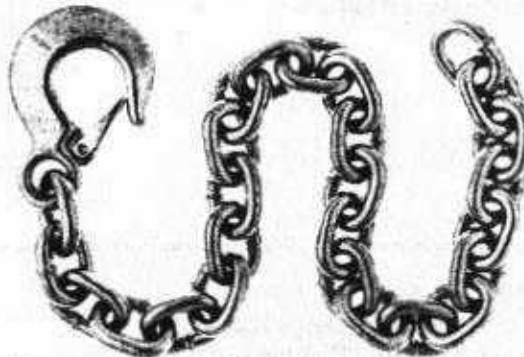

**3BM**

Chrome tri-ball mount  
1-7/8", 2", 2-5/16"

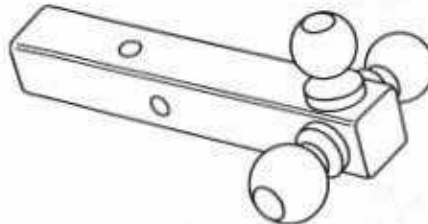

**ADJ3BM**

Adjustble tri-ball mount

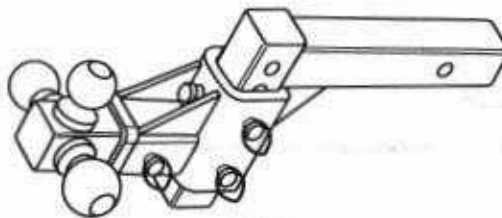

**R12**

12 ton pintle

**R15**

15 ton pintle

**R20**

20 ton pintle



# Hitch Parts / Locks

Part No. Description

**DPH2** Dual purpose hitch 2"  
**DPH2516** Dual purpose hitch 2-51/6"

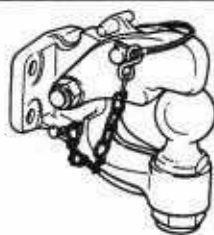

**PM4** Pintle mounting plate - short  
with 4 pairs of 9/16" holes

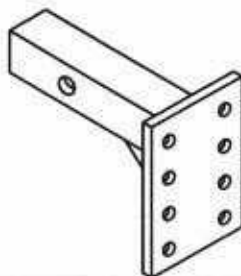

**PM7** Pintle mounting plate - long  
with 7 pairs of 9/16" holes

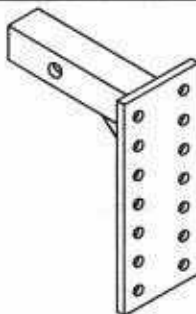

**HP1/2** Locking Hitch Pin Assembly Class II 1/2" dia. pin  
**HP5/8** Locking Hitch Pin Assembly Class III 5/8" dia. pin

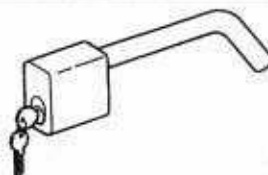

**SCL** Trigger Style Coupler Lock  
3/4" wide span



**WCL** Deadbolt coupler lock  
for 2-1/2" wide span



**L11232** Door Holder - Hook & Keeper  
Hook is 4" long. Includes 1 hook  
and 1 keeper.



# Jack Parts

Part No.      Description

---

**SAJW**

Swing Away Jack w/Wheel  
800 lbs.

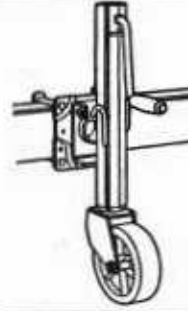

**PMJ**

Post Mount 3 Hole Jack  
2,000 lb.



**6W**

Wheel for 2 1/4" Jacks

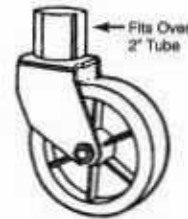

**JF**

Jack Foot with Pin

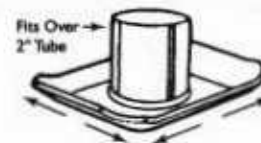

**RB**

2 1/2" Round Rubber  
Bumper

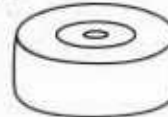



# Connectors, Wiring, Controllers, Lights

Part No.

Description

- 44P** 4 Way Flat Trailer End Plug  
**44S** 4 Way Flat Car End Plug  
**11-771** Mounting Bracket for S-602  
**S-602** 6 Pole Aluminum Trunk End Plug  
**S-603** 6 Pole Aluminum Trailer End Plug  
**12-701** Mounting Bracket for 12-707  
**12-706** 7 Pole Plastic RV-Trailer  
**12-707** 7 Pole Plastic RV-Truck

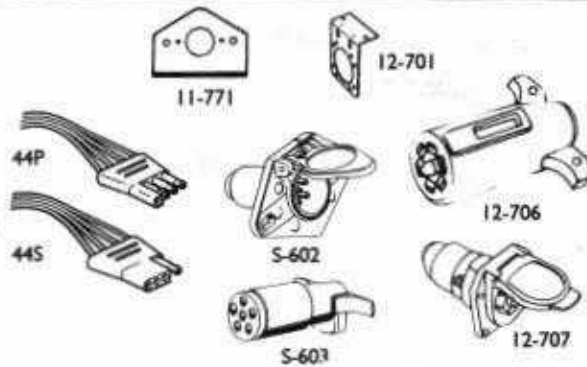

- ADP624** 6 Way Round to 4 Way Flat Adapter



- ADP724RV** 7 Way RV to 4 Way Flat Adapter



- ADP726RV** 7 Way RV to 6 Way Round Adapter



- D5500** DrawTite Brand Activator II  
 Brake control for 2, 4, 6 & 8 Brake Trailers  
 Adapter plugs for prewired trucks - Ford,  
 Dodge, Chevy

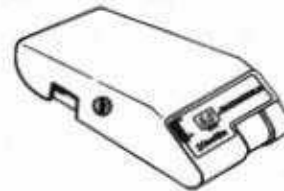

- 444R** Square light - driver side  
**444L** Square Light - passenger side  
**44415R** Square replacement lens

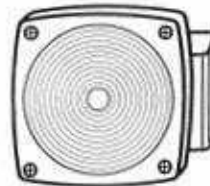

- 428S** Round 3-3/4" light - driver side  
**428W** Round 3-3/4" light - passenger side  
**42015R** Round lens

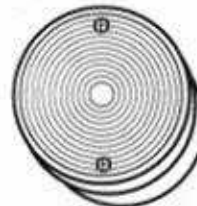

- 114A** Marker light - amber  
**114R** Marker light - red  
**11415A** Amber replacement lens  
**11415R** Red replacement lens

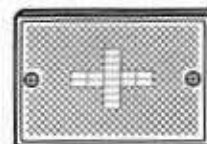

# Trimmer and Blower Racks for Open Trailers

Part No.	Description
----------	-------------

<b>OTR3</b>	Open Trimmer Rack
<b>OBRI</b>	Open Backpack rack

**Our  
Own Exclusive  
Design**

## String Trimmer Racks for Open Trailers

**Lock 3 trimmers  
in 2 seconds  
with 1 padlock**

Extra sturdy racks – mount to bottom and top rail of trailer – stops wiggle and cracking at top rail.

Backpack Blower Rack has a single 4"x1½" hook at the top – make sure it will fit your blowers – will not fit Stihl backpack blowers. Tower is 46" tall with a swivel lock mechanism at the top.

Set consists of 2 towers, one left and one right, designed so that the locking mechanism swings in and away from the engine and the trimmer head. V-shaped pockets with plastic cushion sleeves on the protruding arms wedge and hold trimmers securely so they are less likely to spin and leak fuel. A single pin or lock secures all three locking arms by aligning lock tab holes at the top of towers. Towers are 46" high, made of 1"x2" steel C channel. Black painted finish.

## INSTALLATION INSTRUCTIONS

1. Observe that there are left-hand and right-hand towers. The reason for right and left towers is so the swivel lock arms swing in and away from the engine, and the trimmer heads of your string trimmers.
2. Position the two towers approximately 40" apart. The swing arms should be to the inside of the rack towers. Check your string trimmers to be sure they will sit in the pockets, and if necessary, move them closer or further apart to suit.
3. **Methods for Fastening the Trimmer Towers:** Trimmer towers can be welded in place to the bottom frame, side, and uprights of your trailer. Or, you may secure them with bolts, U-bolts, or angle brackets. In some cases, a spacer device (block of wood, washers, or multiple nuts) may be used to keep the uprights level. Holes must be drilled in the trailer and the tower to facilitate attachment. We recommend 5/16 Grade 5 minimum, or 3/8 Grade 5 to Grade 8 bolts and locknuts for installation. U-bolts or muffler clamps can be used.

Be careful to use the proper length bolts or cut off and file any sharp edges of bolts so they do not stick out where they could tear clothing or injure someone.

The trimmer towers were intentionally made long enough to extend to the top and bottom of the trailer in order to add strength. The following illustrations should help you decide on a mounting method that suits your trailer.

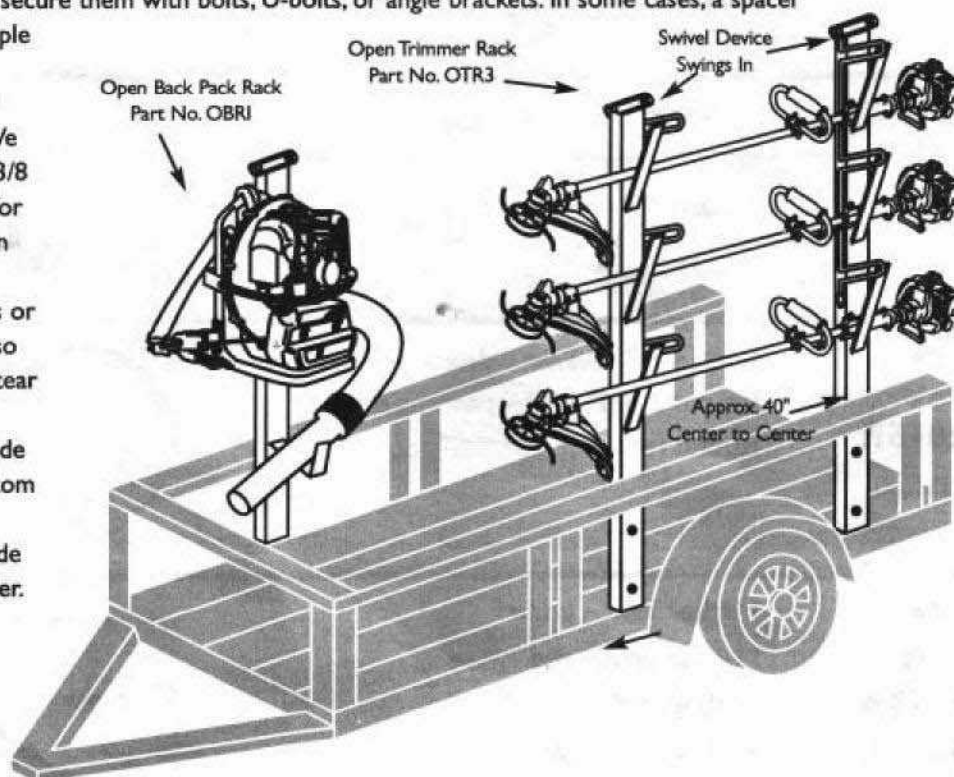

# Jacks / Ramp Spring Assist Kit

Part No. Description

**PT500-I** Topwind Jack 7,000 lb. with bracket welded on (provide us with measurement)

**PT510-I** Sidewind Jack 7,000 lb. with bracket welded on (provide us with measurement)

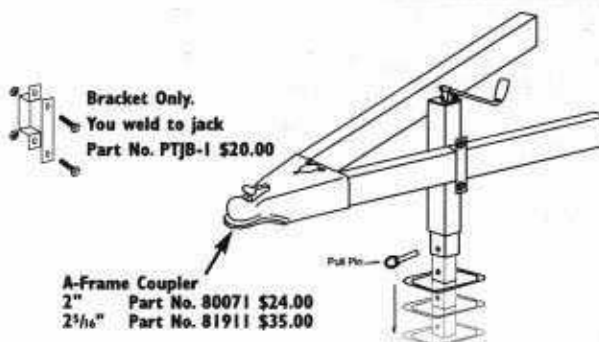

**190500** Topwind Dropleg Jack 7,000 lb.

**190510** Sidewind Dropleg Jack 7,000 lb.

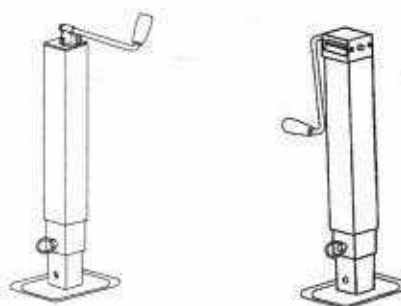

## RSAK001 Ramp Spring Assist Kit

Consists of 2 brackets which mount to the top angle iron, or box tube top rails of a typical landscape trailer, two springs with internal safety cables, and external thick rubber bellows.

Mounting requires drilling three 3/8" diameter holes in the top rail, and attaching with 3/8" bolts. Attachment of the other end of the spring assembly to the top of the ramp requires drilling one 3/8" hole 27" to 28" from the bracket hole, and attaching with a 3/8" grade 8 bolt and locknut. Complete Instructions will be sent with the kit.

Installation should take approximately 1/2 hour or less.

The results are dramatic, making the gate much easier to lift. This system works better, providing more upward lift when the gate is in the down position, because the rail brackets raise the angle of pull to a higher point.

The mechanism uses very little space on your trailer rails leaving room for other racks. This is the lowest priced spring assist kit that installs this easily, and works this well.

If in doubt about whether this system will work for you, please either fax a drawing, or mail a picture with dimensions, or have your local trailer mechanic contact us. We would be happy to set him up as a dealer.

